

NARVA® 20W Square LED
Worklight - Flood Beam
#72449

www.narva.com.au



DESCRIPTION

9-64V, 20W flood beam LED worklight. Contains 4 x 5W LED's producing 2,000 Lumens. Fully sealed and is weatherproof up to IP66 rating. Features die-cast, powder coated aluminium housing, stainless steel mounting hardware and virtually unbreakable polycarbonate lens.

TECHNICAL SPECIFICATIONS

DIMENSIONS

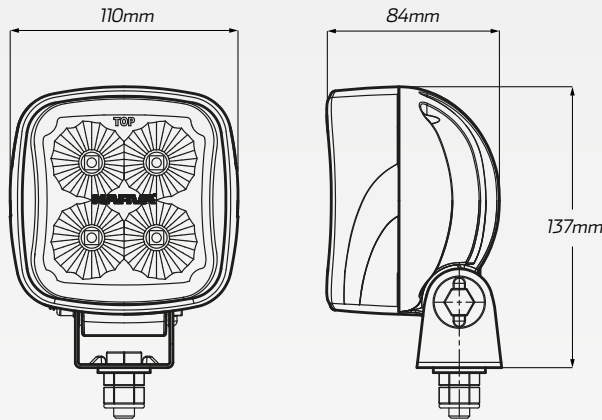

FLOOD

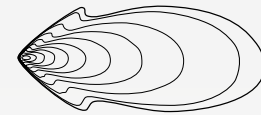

Voltage Range	• 9-64 Volt
Wattage	• 20 Watt
Current Draw	• 1.3A @ 12V / 0.7A @ 24V
LED Count	• 5 x 4W High Powered LED's
Beam Coverage	• Flood Beam
Lumens Rating	• 2,000 Lumens
Dimensions	• 110mm W x 137mm H x 84mm D
Body Material	• Die-cast Aluminium Housing
Lens Material	• Polycarbonate Lens
IP Rating	• IP66 Rated
Wiring	• Pre-wired 0.5m cable

BEAM COVERAGE

At a 12° angle (2.5m high)

