



**DT Series 3 Circuit
Deutsch Connector Kit**
#DT3

www.te.com



DESCRIPTION

3 circuit DT Series Deutsch connector kit.

Deutsch DT Series of environmentally sealed connectors are designed specifically for cable to cable applications on the engine or transmission, under the hood, on the chassis or in the cab. Thermoplastic housing and silicon rubber seals.

Perfect for harsh environmental applications where reliable signal circuits are critical to operation performance.

- Accepts contact size 16 (13 amps)
- In-line, flange or PCB mounts available
- Thermoplastic housing
- Intergrated latch for mating
- Wedgelocks confirm contact alignment and retention

PRODUCT BREAKDOWN

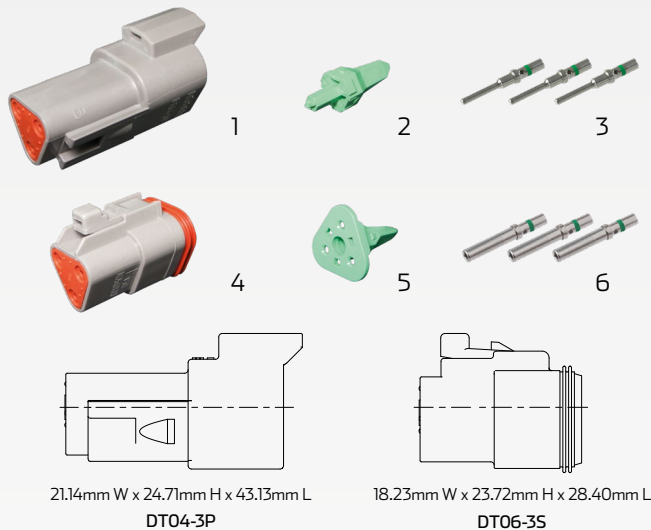

COMPONENTS

No.	Part No.	Description
1	DT04-3P	• 3 circuit DT series receptacle housing to take male pins
2	W3P	• 3 circuit pin wedge
3	P16GN/1	• Male pin. Takes 3 - 4mm auto cable
4	DT06-3S	• 3 circuit DT series plug housing to take female sockets
5	W3S-P012	• 3 circuit socket wedge
6	S16GN/1	• Female socket. Takes 3 - 4mm auto cable

TECHNICAL SPECIFICATIONS

Connector System	• Wire to wire
Primary Locking Feature	• Integrated in housing
Number of Positions	• 3 positions, 0 row
Mating Pin Diameter	• 1.59mm
Contact Rating	• 13A max per contact
Voltage Rating	• Up to 250 Volt DC / AC
Operating Temperature	• -55°C to 125°C

Flammability	• UL recognized, standard UL-94
Agency Standard	• SAE J2030
Insulation Resistance	• 1000MΩ minimum at 25°
Vibration Resistance	• No mechanical / physical damage @ 20Gs rms at 10 to 2000Hz
IP Rating	• IP68 and IP69K (with protection such as backshell)
Dielectric Withstand Voltage	• Current leakage < 2mA @ 1500V AC