

QVEE LED Interior Lamp With ON/OFF Switch

#QVI260WBL24

AUTOMOTIVE | MINING | MARINE

www.qvee.com.au



DESCRIPTION

QVI260WBL 24V LED Interior lamp with White End Caps.

The light is fitted with 36 ultra bright SMD LED's and an ON/OFF rocker switch.

Ideal for tool boxes, motor homes, caravans, etc.

- Voltage: 24 Volt
- Easy to install surface mount
- Waterproof, shockproof and rustproof
- Up to 100,000 hours estimated life span

DIMENSIONS

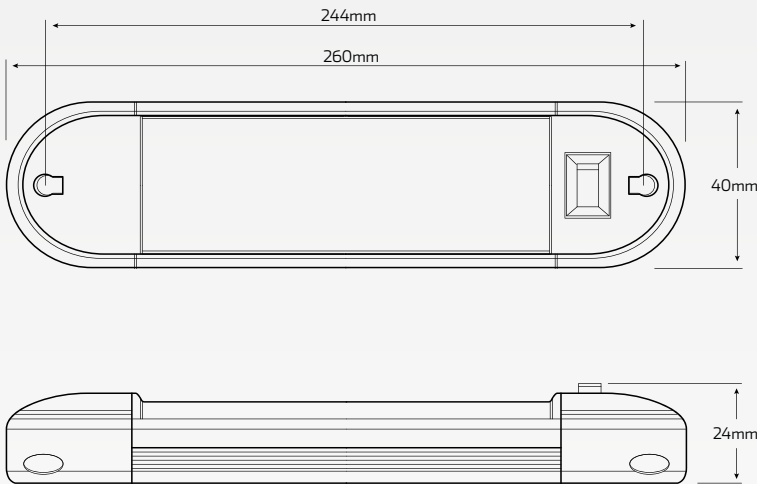

Comes with pre-wired twin core cable



Easy to mount

ACCESSORIES

- Fitting Screws

TECHNICAL SPECIFICATIONS

Voltage	• 24 Volt	Estimated Working Life	• 100,000 Hours
LED Count	• 36 SMD LED's	Mount	• 244mm Centre to Centre
Lens Material	• Polycarbonate Lens	Dimensions	• 260mm L x 40mm W x 24mm D
Base Material	• Aluminium Base (ADC12)	Approvals	• CE Certification, RoHS