



97dB "Broadband"  
Sound Reverse Alarm

#RABBS97

www.brigade-electronics.com



**DESCRIPTION**

"Shhhh Shhhh" Broadband sound reverse alarm. The BBS-TEK broadband alarms use multi-frequency broadband sound instead of the traditional single frequency sound of a conventional alarm. The sound dissipates much quicker, is directional, and localised in the danger zone, resulting in an enormous reduction in noise and nuisance complaints.

**FEATURES**

- Multi-frequency broadband sound
- Instantly locatable
- Sound confined to danger area
- Eliminates noise nuisance
- Sounder unit: speaker
- Water and dust proof - IP68



**TECHNICAL SPECIFICATIONS**

**DIMENSIONS**

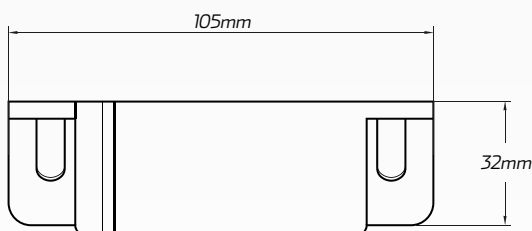
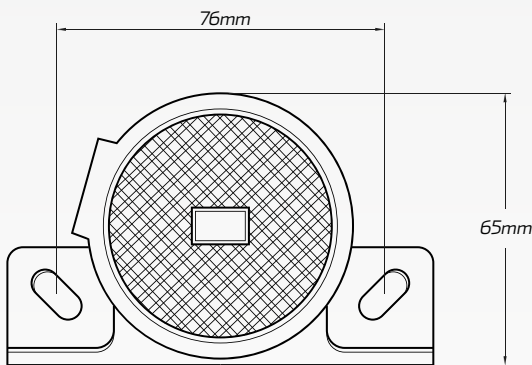

<b>Voltage</b>	• Multivolt 12 - 24 V DC
<b>IP Rating</b>	• IP68
<b>Amperage</b>	• Max 0.5 Amps
<b>Decibels @ 1m</b>	• 97dB
<b>Frequency</b>	• Multi
<b>Sounder Unit</b>	• Speaker
<b>Mechanical Vibration</b>	• 10 G
<b>Operating Temperature</b>	• -40°C to 85°C
<b>Dimensions</b>	• 105mm W x 65mm H x 37mm L
<b>Hole Centres</b>	• 76mm / 3"
<b>Approvals</b>	<ul style="list-style-type: none"> <li>• CE Marker</li> <li>• EMC Approved: E</li> <li>• SAE J994</li> </ul>